

Effect of microstructure on the sonotrode properties of tool materials Ferro-titanit[®] WFN and steel CPM 10V[®]

Š. Emmer¹, P. Baksa¹, J. Kováčik^{2*}

¹*Institute of Technologies and Materials, Faculty of Mechanical Engineering, IVMA STU, Slovak University of Technology, Pionierska 15, 831 02 Bratislava, Slovak Republic*

²*Institute of Materials and Machine Mechanics, Slovak Academy of Sciences, Račianska 75, 831 02 Bratislava, Slovak Republic*

Received 11 June 2015, received in revised form 23 September 2015, accepted 24 September 2015

Abstract

Two patented tool materials cermet Ferro-titanit[®] WFN and steel CPM 10V[®] are evaluated from the point of view of their sonotrode properties. The comparison criterion was ultrasonic energy transmission for each tool material. The maximum oscillation amplitude at lowest input power at a constant resonant frequency of 30 kHz and given voltage was measured. Both particulate composite systems are prepared by the methods of powder metallurgy thus having high structural homogeneity. Structural analysis showed that the cermet Ferro-titanit[®] WFN is a particulate composite material having aggregated hard TiC phase within the matrix. On the contrary, steel CPM 10V[®] is a particulate composite material with segregated and homogeneously dispersed hard VC phase within the matrix. The difference in the spatial distribution and aggregation/segregation of hardening phase within the matrix is a key factor that affects their ability to transmit ultrasound energy.

Key words: ultrasonic, sonotrode materials, tool materials, sonotrode tool materials, powder metallurgy, microstructure, transmission of ultrasound energy

1. Introduction

Currently in high-performance ultrasound applications (20–100 kHz) there is a requirement for sonotrode tool materials. Tool material that could be a sonotrode tool material must have not only the features of a tool material (high hardness and abrasion resistance), but also must highly conduct ultrasonic energy. Currently, as the best sonotrode materials are considered precipitation hardened aluminium alloy AW 7075 and titanium alloy Ti6Al4V. However, these alloys do not fulfil the requirements for tool materials [1].

The simple solution is to use usual tool material as sonotrode tool material. In this case, it is necessary to determine experimentally if such material can be used in sonotrode applications. In our previous works [2, 3] were published the results of these experiments. However, the explanation why these tool materials can transmit more efficiently the ultrasonic energy was

missing. Therefore, the aim of this article is to explain the connection between microstructure and ultrasonic energy transmission.

2. Experimental

The Ferro-titanit[®] WFN and CPM 10V[®] tool materials were investigated. Ferro-titanit[®] WFN is a metal-ceramic tool material (cermet) [4, 5] whose chemical composition is following: 33.00 wt.% TiC, 0.75 wt.% C, 13.50 wt.% Cr, 3.00 wt.% Mo and Fe balanced. This material is produced by powder metallurgy. The matrix of the cermet is Cr-Mo steel with embedded 33.00 wt.% (or 45 vol.%) of titanium carbide. In industry, in addition to its use as a tool material for cold operation such as cutting and forming, it is also used for tools and parts highly resistant to wear. Ferro-titanit[®] WFN possesses high resistance to tempering up to 450 °C, and also increased corrosion

*Corresponding author: e-mail address: ummsjk@savba.sk

resistance. Recently, it was also used for applications in the transmission of ultrasonic energy as sonotrode tool material [5]. Heat treatment was done in a vacuum oven. Heating to austenitic temperature 1080 °C was done in three-stage pre-heating at 400, 650 and 850 °C. After reaching the austenitic temperature, the cooling down to 50 °C was conducted in argon at a pressure of 0.1 MPa. It was immediately followed by the tempering near the hardness secondary maxima peak at 480 °C for 2.5 h.

High-performance CPM 10V[®] steel with increased content of vanadium and carbon also produced by powder metallurgy method is hardenable at air. The combination of the toughness, wear resistance and cutting edge stability predestined it to substitute tool steels, which are during cold working prone to chipping of cutting edge of the tool [6]. Its chemical composition is following: C max. 2.45 wt.%, Si max. 0.90 wt.%, Mn max. 0.50 wt.%, Cr max. 5.25 wt.%, Mo 1.30 wt.%, V 9.75 wt.% and Fe balanced. The heat treatment of this steel was necessary as semi-products were delivered after soft annealing. Heating to the austenitic temperature of 1060 °C was done by two-stage pre-heating at 470 and 860 °C. Holding at austenitic temperature 1060 °C was 30 min. The cooling was done in the salt bath at 550 °C, and then in the air to a temperature below 50 °C. The tempering was done in two steps, the first tempering was at a temperature of 560 °C for 2 h, and the second tempering was at 550 °C for 2 h to achieve the proper hardness, optimal wear resistance, and toughness.

The hardness HRC was measured using HRC-HB hardness machine type KP 15002P.

Samples for determining ultrasonic properties were produced in the state after soft annealing, and then heat treated. Production of samples is difficult because of the necessity of their high dimensional and shape accuracy. Also, test cylindrical samples have been made to control the thermal treatment of the samples for testing of ultrasonic energy transmission. On the basis of the mechanical and physical properties, the velocity of sound in these tool materials was calculated. Subsequently by computer simulations the length of the sample l_0 was determined so that during the experiments the sample would have desired resonant frequency of 30 kHz. The shape of the test specimen for measuring of the transmission of the ultrasonic energy is in Fig. 1. The detailed description of the experimental device is in [2]. The device enables to vary the power source voltage in the range of 50–250 V. It can measure the deflection of the sample using a micrometer and also input power into the sample. The tests were conducted with and also without the booster. During the test 300 W transducer was used. The experiments were carried out on the samples before and after heat treatment.

Light microscope ZEISS Axiovert 40 MAT and

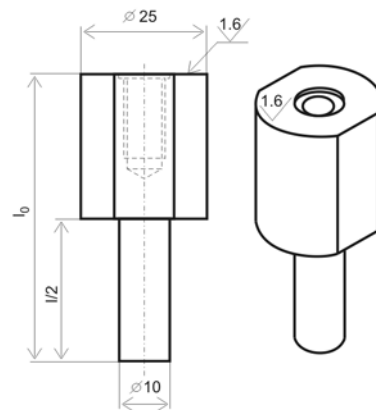

Fig. 1. Shape and dimensions of the test sample for ultrasound transmission.

electron microscope JEOL 7600F, equipped with a Schottky thermal-emission cathode (thermal FEG – W-coated ZrO₂) as well as energy and wavelength spectrometers from Oxford Instruments were used for microstructure characterization.

3. Results and discussion

Supplied semi-finished product of Ferro-titanit[®] WFN, despite the fact that it was in a state after soft annealing, had a significantly high hardness of 46 HRC. After sample machining, as was defined above, the heat treatment was done in a vacuum oven. With respect to single steel austenitic temperature and tempering time, it has to be adjusted due to the fact that it is a metal-ceramic material, where the ceramic skeleton of TiC greatly affects the heat treatment parameters, and therefore, the resulting structure. The resulting structure is characterized by high hardness, but in the case of incorrect heat treatment also by the formation of microcracks caused by thermal shocks or by residual stresses. After the proper heat treatment, the observed microstructure of Ferro-titanit[®] WFN consists of a martensitic matrix with embedded titanium carbide particles (Fig. 2). TiC particles are aggregated as confirmed also SEM EDX analysis. Hardness measured after the heat treatment was 64⁺¹ HRC. However, depending on the heat treatment parameters, the hardness of 68 HRC [4] can be achieved.

The microstructure of CPM 10V[®] steel consists of a ferrite-carbide matrix with equally spaced secondary acicular and globular carbide phase (see Fig. 3), which, compared to steels produced via classical metallurgy, is significantly smaller. For this reason measured hardness after heat treatment was 61⁺² HRC.

The experimental tests concerning the transmission of ultrasonic energy have been carried out with

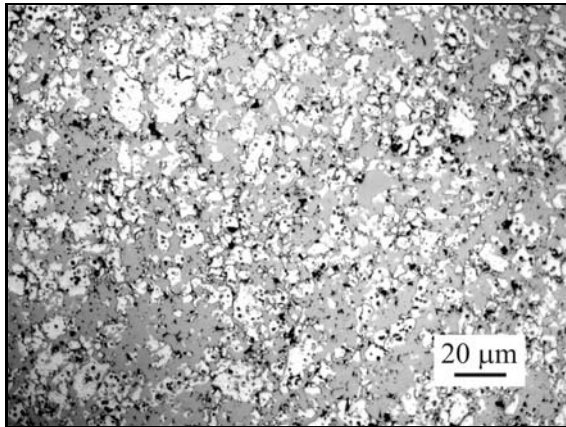

Fig. 2. Light microscopy structure of Ferro-titanit® WFN hardened and tempered (dark grey area – TiC).

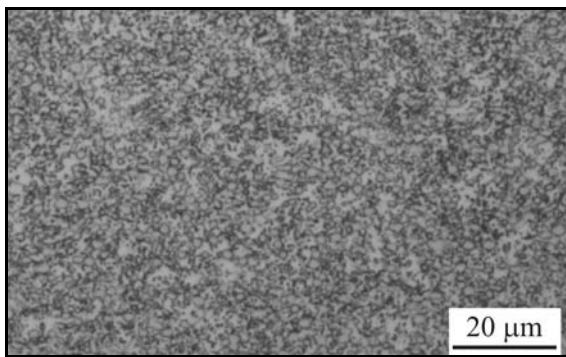

Fig. 3. The microstructure of CPM 10V® steel after heat treatment with fine carbide phases in the matrix.

the booster (converter of oscillation amplitude) and without. The criteria for the comparison of ultrasound energy transmission of individual samples were defined as follows: achieved maximum oscillation amplitude or minimal power consumption at the resonant frequency of 30 kHz and at constant voltage of power source which creates ultrasonic oscillations. From the point of view of practical applications, the experimental results without booster are more interesting.

Figures 4 and 5 show the experimental results of the transmission of ultrasonic energy from the point of view of input power consumption, and the displacements at the tip of the sample at the resonance frequency of 30 kHz. In the case of required input power Ferro-titanit® WFN in all experiments needed lower input power for the transmission of ultrasound waves, which may be related to its lower density when compared to steel CPM 10V®. However, in the case of Ferro-titanit® WFN the measurements were carried out only to the voltage of 150 V. At a higher voltage of 200 V the sample fractured already.

Steel CPM 10V® reached during measurements of

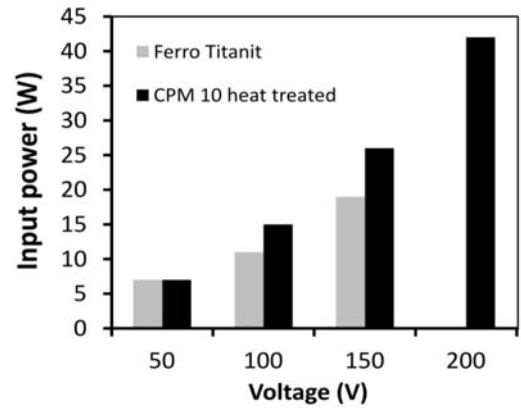

Fig. 4. Comparison of input power into Ferro-titanit® WFN and CPM 10V® after heat treatment at a different voltage (without booster).

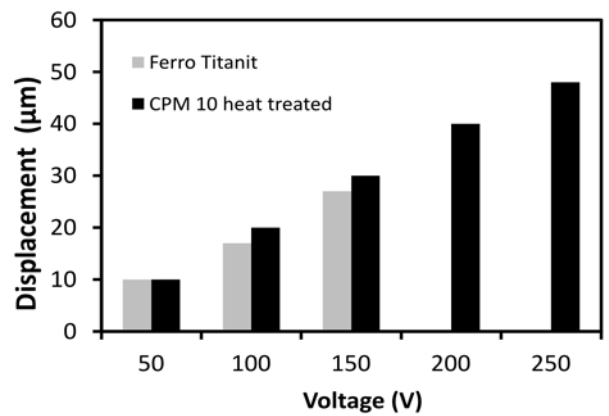

Fig. 5. Comparison of tip displacement of Ferro-titanit® WFN and CPM 10V® samples after heat treatment at a different voltage (without booster).

the sample tip displacement the largest values at all used voltages. The fracture of the sample was observed at the highest test voltage of 250 V. These results can be related to the greater homogeneity of its structure when compared to cermet Ferro-titanit® WFN.

In the case of sonotrode materials, their resistance to high-cycle (or gigacycle) fatigue is also important. This resistance depends not only on the homogeneity of the microstructure, but also on other factors such as the presence of inclusions in microstructure, the degree of imperfections in crystal structure and on the number of other physical, mechanical and microstructural properties of the investigated material [7, 8].

After the ultrasonic experiments, the fractured surfaces of samples were investigated using SEM microscopy (Figs. 6, 7). Figure 6 displays the fractured surface of Ferro-titanit® WFN heat treated after determination of ultrasonic characteristics. The brittle fracture of TiC particles is evident. On the contrary,

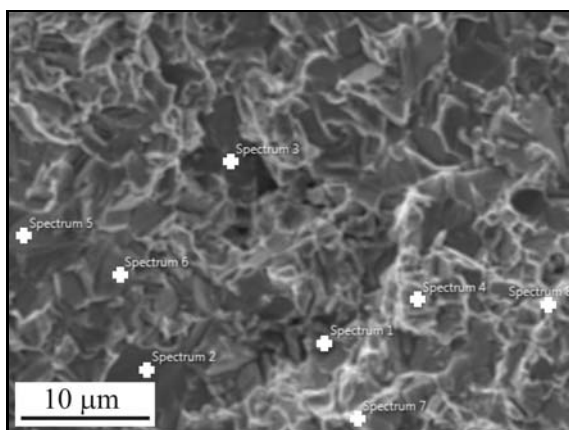

Fig. 6. Fractured surface of Ferro-titanit[®] WFN cermet and the points of EDX analysis.

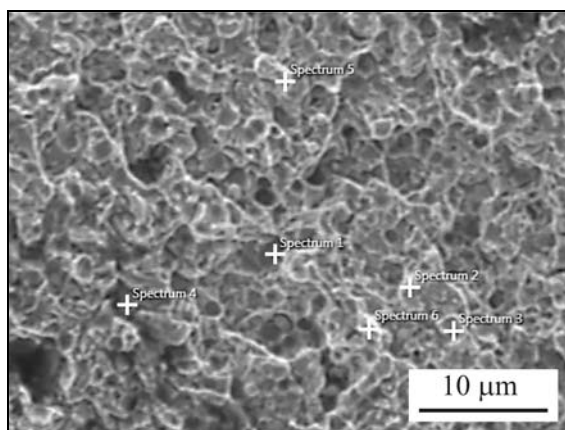

Fig. 7. Fractured surface of CPM 10V[®] steel and the points of EDX analysis.

Cr-Mo matrix exhibits ductile rupture. The Spectra points 1 through 8 were chosen to perform EDX analysis of elements. The results of EDX analysis of the elements (in at.%) in Spectra points 2, 3, 5–7 confirmed the presence of titanium carbide particles of

the size up to 10 microns.

The fractured surface of CPM 10V[®] steel heat treated after determination of ultrasonic characteristics is in Fig. 7. In this case, the brittle fracture of carbide particles also takes place, but the particles are

Table 1. Element analysis of fractured surface of Ferro-titanit[®] WFN cermet (Fig. 6) in at.%

Spectrum Element	1	2	3	4	5	6	7	8
O	19.75	–	–	–	–	–	–	–
Al	0.50	–	–	–	–	–	–	–
Si	–	–	–	0.61	–	–	0.25	0.50
S	6.61	–	–	–	–	–	–	–
Cl	1.25	–	–	–	–	–	–	–
Ti	5.37	97.54	90.23	8.87	41.95	87.94	30.57	10.06
V	–	–	3.30	–	–	–	–	–
Cr	–	–	1.21	–	–	–	–	–
Fe	7.98	–	5.01	55.63	0.48	1.74	15.10	42.13
Cu	50.13	–	–	–	–	–	–	–
Zn	6.99	–	–	–	–	–	–	–
Mo	–	–	0.25	0.33	0.71	1.04	1.31	0.56

Table 2. Element analysis of fractured surface of CPM 10V[®] steel (Fig. 7) in at.%

Spectrum Element	1	2	3	4	5	6
N	–	5.30	–	–	–	–
O	–	–	1.41	4.73	1.68	1.18
F	–	–	4.00	–	4.22	1.11
Si	–	0.67	1.54	1.87	1.45	0.61
Ca	–	–	–	0.96	–	–
V	78.31	45.44	1.76	2.19	1.70	1.89
Cr	10.07	8.59	5.57	6.03	5.26	5.23
Fe	8.02	37.41	85.31	84.22	85.29	89.99
Mo	3.59	2.59	0.41	–	0.40	–

much smaller as in Ferro-titanit[®] WFN cermet. Due to this it can be concluded that the fracture of this steel is significantly tougher when compared to cermet. Also in this case in Spectra points 1–6 EDX analysis was performed. After the evaluation of obtained atomic percent of measured elements at the points 1 and 2 it can be concluded that the dominant phase present in this points is phase based on V. The observed phase consists evidently of vanadium carbide of size of 3 microns. Besides vanadium carbide, the presence of other homogeneously distributed carbides in the matrix is evident (see Table 2). There are also carbides of other alloying elements of steel CPM 10V[®] (Cr, Mo), and their size is also below 3 microns.

Cermet Ferro-titanit[®] WFN can be considered as a composite particulate system. In the particulate composite system, the particles must be homogeneously dispersed in the matrix, and it is necessary to avoid aggregation. There is also a requirement for the shape factor of the particles, which should be close to 1. The obtained microstructure analyses have shown that in the case of the cermet Ferro-titanit[®] WFN, carbide particles of the size of 10 microns (TiC – 33.00 wt.% or 45 vol.%) introduced to the Cr-Mo steel matrix are aggregated. It can be concluded that it is a composite particulate system of the second type in which the embedded phase is aggregated after achieving the maximum density and creates locally also large continuous clusters [9].

Based on the structure analysis for steel CPM 10V[®] more homogeneous distribution of carbide phases in a steel matrix was observed when compared to the cermet Ferro-titanit[®] WFN. More homogeneous distribution, as well as the significantly smaller particle size of carbide phases with the size below 3 μm in the steel matrix of CPM 10V[®] is the way of its production. In this case, the tool material CPM 10V[®] can be considered as a particulate composite system of the first type in which dispersed phase is segregated [9].

Cermet Ferro-titanit[®] WFN is made by compaction of a mixture of TiC carbide powder and Cr-Mo steel alloy powder. Then, depending on the mixing method and the final compaction method, the TiC particles reach only a certain degree of homogeneity distribution in Cr-Mo steel matrix. On the contrary, the secondary hardening fine carbide phase in the matrix of the CPM 10V[®] steel was created in situ in the matrix via precipitation from the supersaturated solid solution. The difference in the technology of preparation leads to the difference in resulting microstructure, and finally to the difference in the transmission of ultrasonic energy of each material.

It can be concluded that the preparation method of composites used for the transmission of ultrasonic energy significantly affects the size, homogeneity and spatial distribution of embedded phase in composite matrix, and also on the level of its aggrega-

tion/segregation. So the embedded phase handles better/worse transmission of ultrasonic energy in the case of investigated materials.

4. Conclusions

The sonotrode properties at 30 kHz of Ferro-titanit[®] WFN and CPM 10V[®] tool materials were investigated. The hardness of them measured after the heat treatment was 64⁺¹ HRC and 61⁺² HRC, respectively. Cermet Ferro-titanit[®] WFN is made by compaction of a mixture of TiC carbide powder and Cr-Mo steel alloy powder. For this reason, the embedded titanium carbide particles are aggregated of the size up to 10 microns. Moreover, they incline to create large clusters in steel matrix. On the contrary, carbide phase in the matrix of the CPM 10V[®] steel was created in situ via precipitation from the supersaturated solid solution. For this reason, finer carbide phases are equally spaced with size below 3 microns. The most important difference is that carbide phases are segregated in this case. For this reason, it was observed that the best results for ultrasonic energy transmission were achieved for high vanadium alloy steel CPM 10V prepared by powder metallurgy. Measurement of the amplitude of sample oscillations without breaking was possible up to the voltage of 200 V. The sample fractured at 250 V. This steel has exceptional resistance to wear [10] due to fine and randomly distributed VC phase in the steel matrix after heat treatment.

Acknowledgements

This work was supported by the Slovak Research and Development Agency under the contract VMSP II-0009-09 and the Slovak Grant Agency under contracts VEGA 1/0189/12 and 2/0158/13.

References

- [1] Cheers, C. F.: Design and Optimisation of an Ultrasonic Die System for Forming Metal Cans. [Ph.D. thesis]. Loughborough, Loughborough University of Technology 1995.
- [2] Emmer, Š., Kováčik, J.: Key Engineering Materials, 601, 2014, p. 21.
[doi:10.4028/www.scientific.net/KEM.601.21](https://doi.org/10.4028/www.scientific.net/KEM.601.21)
- [3] Emmer, Š., Kováčik, J., Mrkvová, S.: Scientific Proceedings Faculty of Mechanical Engineering, 21, 2013, p. 44.
- [4] Ferro-Titanit[®] Powder-Metallurgical Carbide Alloyed Materials. Krefeld, Deutsche Edelstahlwerke GmbH. 2007.
- [5] http://www.ferro-titanit.com/fileadmin/files/ferro-titanit.com/documents/027_DEW_Ferro_Titanit_D.pdf

- [6] Haswell, W. T., Kasak, A.: Powder-Metallurgy Steel Article With High Vanadium-Carbide Content. US Patent US4249945A. 1981.
- [7] Furuya, Y., Matsuoka, S., Abe, T., Yamaguchi, K.: *Scripta Materialia*, 46, 2002, p. 157.
[doi:10.1016/S1359-6462\(01\)01213-1](https://doi.org/10.1016/S1359-6462(01)01213-1)
- [8] Bandara, Ch. S., Siriwardane, S. C., Dissanayake, U. I., Dissanayake, R.: *International Journal of Materials, Mechanics and Manufacturing*, 1, 2013, p. 256.
[doi:10.7763/IJMMM.2013.V1.54](https://doi.org/10.7763/IJMMM.2013.V1.54)
- [9] Bareš, R. A.: *Kompozitní materiály*. Praha, SNTL 1987. (in Czech)
- [10] Emmer, Š., Mrkvová, S., Kováčik, J.: *Zváranie – Svařování*, 5–6, 2014, p. 126. (in Slovak)